

INSTALLATION GUIDE

SAFETY & WARNINGS

1. UNLIKE TRADITIONAL DIMMING CONTROLS, SWITCHEX REQUIRES UNIQUE WIRING STEPS. READ ALL WARNINGS AND INSTALLATION INSTRUCTIONS THOROUGHLY.
2. Install in accordance with national and local electrical code regulations.
3. This product is intended to be installed and serviced by a qualified, licensed electrician.
4. CEC Code: Rule 16-212 requires the separation of Class 2 conductors from various other circuits like electric power, Class 1, and electric lighting through appropriate minimum separations or barriers of raceway, cable or other metal or non-metal material.
5. Only install compatible 12V or 24V Constant Voltage DC fixtures or warranty will be void.
6. Do not modify product beyond instructions or warranty will be void.

QUICK SPECS / MODELS

	Input	Output	Max Load
SX-12V-DD-60W	120VAC	12 VDC	60 W
SX-24V-DD-100W		24 VDC	100 W

SUPPLIED ACCESSORIES

SWITCHEX Barrier Face Plate (3)* Twisted Wire Connector (4)

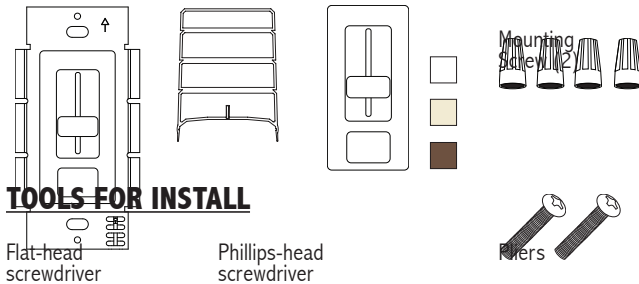

APPROVED 24V LED FIXTURES

LED Strip Series	LED Hard Strip	LED Britestrip
LED eSTRIP	LED Thin Star	
LED Globe Light	LED Mini Star II	

APPROVED 12V LED FIXTURES

LED Mini Disc Light
LED Disc Light

INSTALLATION

1 TURN POWER OFF AT CIRCUIT BREAKER



SHOCK HAZARD! May result in serious injury or death. Turn power OFF at circuit breaker prior to installation.

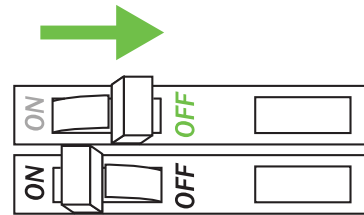

2

DETERMINE LOCATION TO INSTALL COMPONENTS

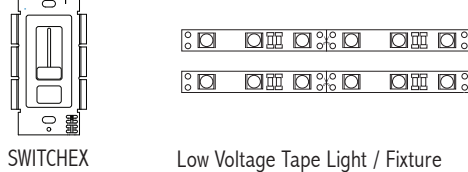

3

REMOVE EXISTING SWITCH (IF NECESSARY)

- a. Remove trim plate and switch mounting screws.
- b. Pull switch from wall.
- c. Identify wires connected to switch and mark wires if desired.
- d. Disconnect wires from switch.

INSTALLATION CONT.

4 CHOOSE FACE PLATE FINISH (IF NECESSARY)

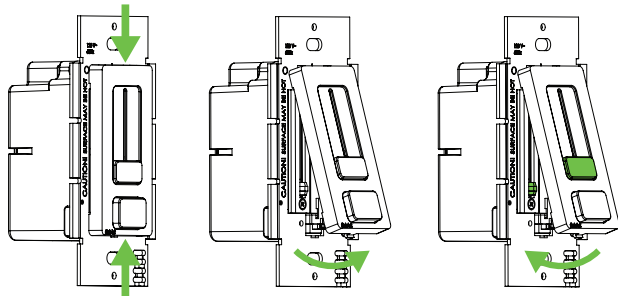

a. Gently squeeze top and bottom of face plate.

b. Lift face plate from housing.

c. Insert replacement face plate into top housing groove. Position housing slider and face plate slider at min brightness (bottom level) and pop on face plate.

5 REMOVING FINS (IF NECESSARY)

It's required to break off dimmer fins when ganging multiple dimmers in same wall box.

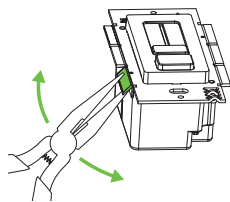

Grip with pliers. Bend back and forth until fin breaks off.

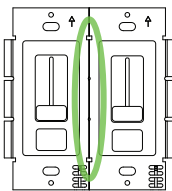

Fins have been removed.

ZERO LOAD DERATING

Unlike standard high voltage AC controls, removing SWITCHEX fins does not reduce the dimmer's maximum wattage rating.

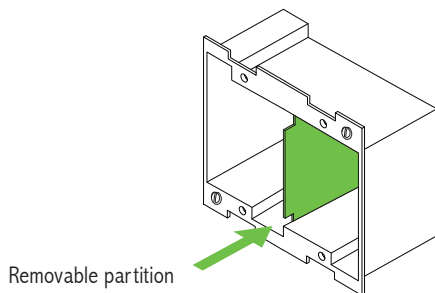

Install gang boxes that include vertical partitions (available at local electrical distributor) unless Class 2 circuit conductors are installed.

6 ATTACH VOLTAGE PARTITION (BARRIER)

A voltage barrier is provided, which separates high voltage and low voltage wires in the wall box. Attach before mounting.

CEC Code: Rule 16-212 requires the separation of Class 2 conductors from various other circuits like electric power, Class 1, and electric lighting through appropriate minimum separations or barriers of raceway, cable or other metal or non-metal material. This also applies to a compartment, outlet box, junction box, or similar fitting with the conductors of electric lighting, power, or Class 1 circuits unless where the power circuit conductors are supplying power for the Class 2 power supply and all conductors are insulated for the maximum voltage of any conductor in the enclosure.

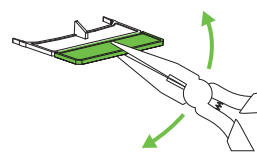
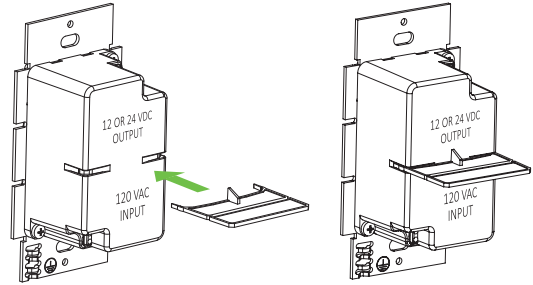

For shallow boxes, barrier can be shortened. Grip with pliers. Bend back and forth until fin breaks off.

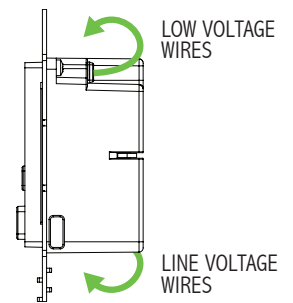

For extra shallow wall boxes it's acceptable to use the dimmer housing as a barrier. Tuck wires on top and bottom sides of dimmer housing.

7 WIRE DIMMER

SPECIAL WIRING INSTRUCTIONS!

SWITCHEX requires unique wiring steps. Read thoroughly.

a. Strip wires on dimmer.

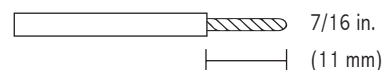

b. Wire dimmer. Ensure main power is OFF.

- GND (GREEN): To ground wire in box.
- V+ (RED): To low voltage V+.
- V- (BLUE): To low voltage V-.
- N (WHITE): To 120 V Neutral.
- H (BLACK): To 120 V Line Hot.

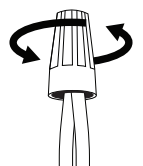

INSTALLATION CONT.

7 CONTINUED.

VOLTAGE DROP

See VOLTAGE DROP CHARTS at end of this guide for wire gauge recommendations installed between dimmer and fixture.

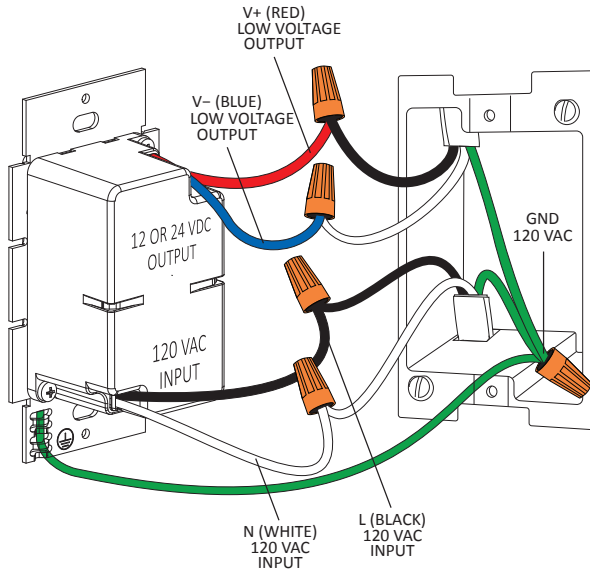

SYSTEM DIAGRAM

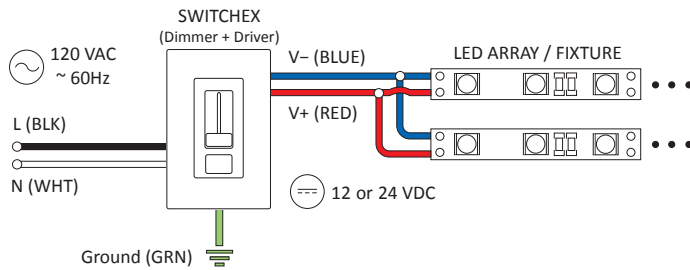

8 MOUNT DIMMER TO WALLBOX AND ATTACH TRIM PLATE

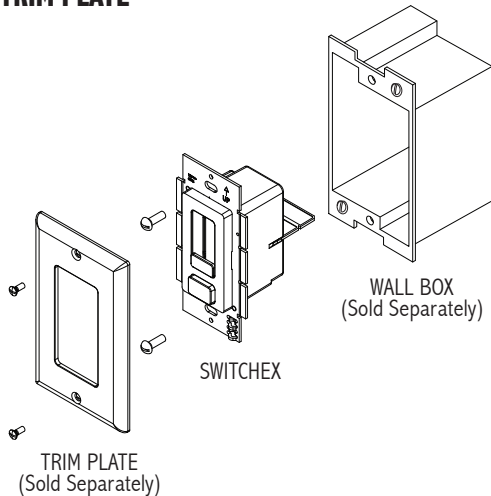

9 TURN POWER ON AT THE CIRCUIT BREAKER

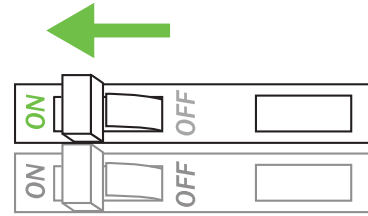

SYSTEM WORKING IMPROPERLY?

Turn power OFF at circuit breaker and verify all connections. Review WIRING and TROUBLESHOOTING

OPERATION

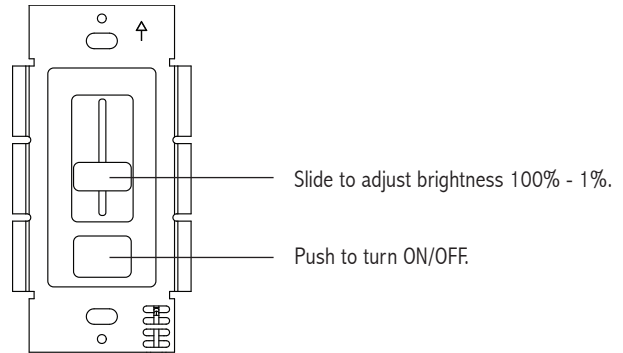

TROUBLESHOOTING

Symptom	Common Cause
Fixture does not illuminate	<ul style="list-style-type: none"> • Incorrect wiring. Polarity of Low Voltage V+ and V- are reversed. • Circuit breaker is OFF or tripped. • Incorrect voltage pairing of dimmer and fixture.
<ul style="list-style-type: none"> • Different fixtures do not dim in sync. • Fixture turns off at low dim level. • Fixture strobos/flickers at low dim level. • Dimmer buzzes excessively 	<ul style="list-style-type: none"> • Only install 24 VDC or 12VDC products on the compatibility list.
Fixture heats up excessively	<ul style="list-style-type: none"> • Incorrect voltage pairing of dimmer and fixture. Do not attach a 12V fixture to a 24V dimmer. • Fixture is not compatible.

VOLTAGE DROP CHARTS

For best performance and lumen output, ensure proper wire gauge is installed to compensate for voltage drop of low voltage circuits.

Example: 12V Voltage Drop & Wire Length Distance Chart

Wire Gauge	10 W .83 A	20 W 1.7 A	30 W 2.5 A	40 W 3.3 A	50 W 2.1 A	60 W 4.2 A
18 AWG	34 ft.	17 ft.	11 ft.	8 ft.	6 ft.	5 ft.
16 AWG	54 ft.	27 ft.	18 ft.	13 ft.	10 ft.	9 ft.
14 AWG	86 ft.	43 ft.	29 ft.	21 ft.	17 ft.	14 ft.
12 AWG	134 ft.	68 ft.	45 ft.	34 ft.	27 ft.	22 ft.
10 AWG	199 ft.	99 ft.	66 ft.	49 ft.	39 ft.	33 ft.

① Determine load size. Let's assume load is 55 W. Round up to nearest load.

② Determine distance from SWITCHEX to load. Let's assume the distance is 20 ft.

③ It's recommended to install 12 AWG to eliminate excess voltage drop.

12V Voltage Drop & Wire Length Distance Chart

Wire Gauge	10 W .83 A	20 W 1.7 A	30 W 2.5 A	40 W 3.3 A	50 W 2.1 A	60 W 4.2 A
18 AWG	34 ft.	17 ft.	11 ft.	8 ft.	6 ft.	5 ft.
16 AWG	54 ft.	27 ft.	18 ft.	13 ft.	10 ft.	9 ft.
14 AWG	86 ft.	43 ft.	29 ft.	21 ft.	17 ft.	14 ft.
12 AWG	134 ft.	68 ft.	45 ft.	34 ft.	27 ft.	22 ft.
10 AWG	199 ft.	99 ft.	66 ft.	49 ft.	39 ft.	33 ft.

24V Voltage Drop & Wire Length Distance Chart

Wire Gauge	10 W .42 A	20 W .83 A	30 W 1.3 A	40 W 1.7 A	50 W 2.1 A	60 W 2.5 A	70 W 2.9 A	80 W 3.3 A	100 W 4.2 A
18 AWG	134 ft.	68 ft.	45 ft.	33 ft.	27 ft.	22 ft.	19 ft.	17 ft.	14 ft.
16 AWG	215 ft.	109 ft.	72 ft.	54 ft.	43 ft.	36 ft.	31 ft.	27 ft.	22 ft.
14 AWG	345 ft.	174 ft.	115 ft.	86 ft.	69 ft.	57 ft.	49 ft.	43 ft.	36 ft.
12 AWG	539 ft.	272 ft.	181 ft.	135 ft.	108 ft.	90 ft.	77 ft.	68 ft.	56 ft.
10 AWG	784 ft.	397 ft.	263 ft.	197 ft.	158 ft.	131 ft.	112 ft.	98 ft.	82 ft.

VOLTAGE ADJUSTMENT

SWITCHEX can provide a 1V boost if the fixture is receiving noticeable light degradation.

- Pop off face plate as shown in Step 4 of INSTALLATION.
- Use a small screwdriver to adjust output voltage by turning adjustment dial clockwise.

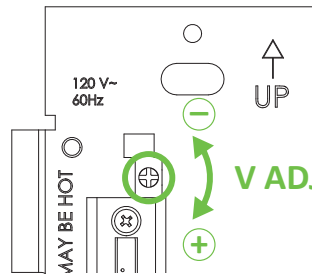

NSL
NATIONAL SPECIALTY LIGHTING
YOUR TRUSTED LIGHTING PARTNER

2299 Kenmore Avenue
Tonawanda, New York 14207

T: 1-800-527-2923 • F: 1-800-527-4358