

Summary

The RF Touch Control Dimmer uses the latest capacitance touch and wireless technology for easy installation and operation.

It is designed for dimming of constant voltage, single color LED products such as: LED Tape Light, LED eSTRIP, LED Globe Light, LED Hard Strip and many more.

Features

1. Ideal for dimming of single color, constant voltage LED products.
2. Remote control with 65 Ft control range.
3. Recent dimming memory feature- remembers the last dimming level after being turned off.
4. Highly sensitive dimming wheel for fast and precise dimming.

Safety Instructions

1. Save these instructions.
2. Read all the instructions thoroughly before commencing assembly or installation.
3. For indoor use only.
4. This product must be installed in accordance with the applicable installation code by a person familiar with the construction and operation of the product and the hazards involved.
5. Use only Class 2 non-dimmable power supplies.
6. Turn off all electrical power before modifying lighting system in any way.

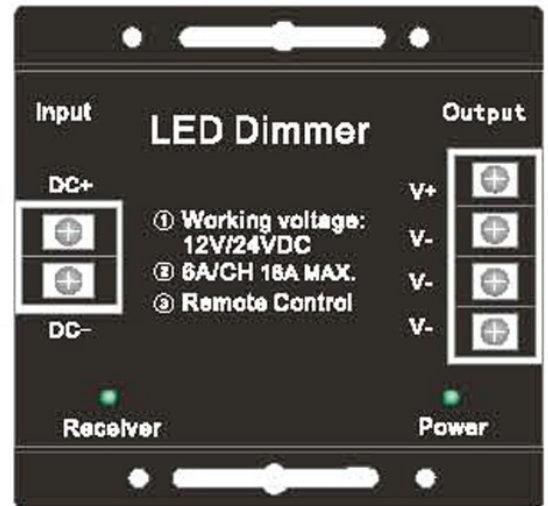





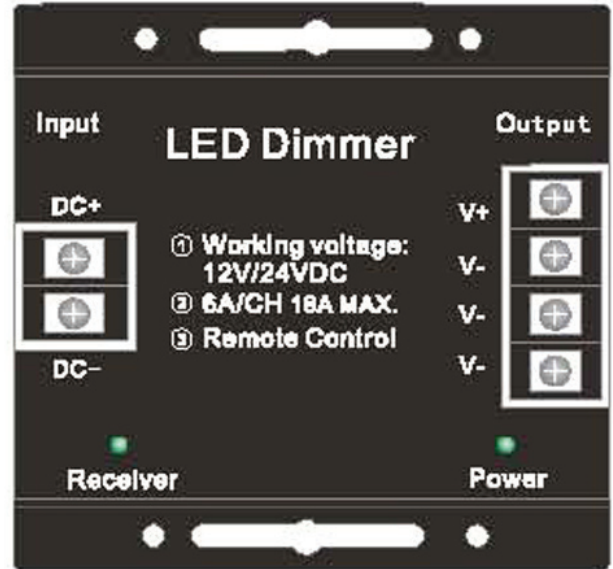

Technical Parameters

CONTROLLER	
Supply Voltage	12V/24V DC
Loadable current	18A (6A per channel)
Output channels	3CH
Output power	216W/432W(12V /24V)
Control method	RF
Connection mode	common anode
Color Choice	1
Dimming method	PWM
Grey steps	256 steps per channel
Protection	The power input polarity protection
REMOTE	
Working voltage	4.5VDC
Remote control way	RF
Launch frequency	433Mhz
Controllable distance	65 Ft
Battery types	3 pcs AAA type batteries (sold separately)
Standby power	0.08mW
Power consumption	6mW
Transmission power	40mW
Key Number	6 touch keys, 1 touch wheel
WHOLE MACHINE	
Working temperature	-20°C-60°C
Identification	CE, RoHS
Weight	0.84lbs
Packing size	L8 $\frac{1}{8}$ "XW5 $\frac{3}{8}$ "XH1 $\frac{3}{4}$ "

Panel and Interface Specifications



Panel and Interface Specifications *(cont'd)*

-  Turn off/on the LED light in any state .
-  Brightness shortcut button: max. brightness or min. brightness.
-  Dimming wheel for selecting the desired brightness.
-  Increases or reduces brightness in 10% increments.
-  Input port (12V/ 24V DC).
-  Output port for connecting LED lights.
-  Green LED lights to show the power and signal receiver state.

Remote Sleep Mode

When the user does not touch the remote for 20 seconds, the remote will automatically enter the low power sleep mode to extend battery life. When the user needs to re-use the dimmer, just touch any key on the remote (except the dimming wheel) to wake up the remote controller for normal use.

Typical Wiring

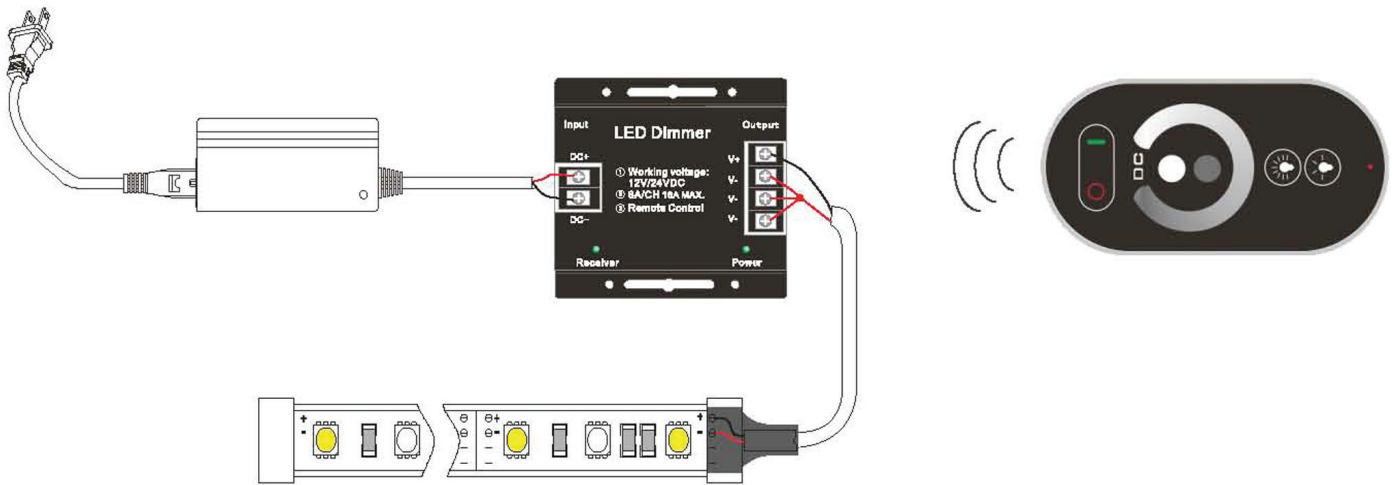

Notes:

1. Use only NSL non-dimmable 24V DC power supplies.
2. Install product as per diagram above (connect the load side first, then connect the power). In this process, please avoid short-circuits.

Signal Amplifiers Diagram

Note: When the load exceeds the dimmer maximum output power, it is necessary to use Signal Amplifiers (NSL part# LT-390A), as per diagram at right:

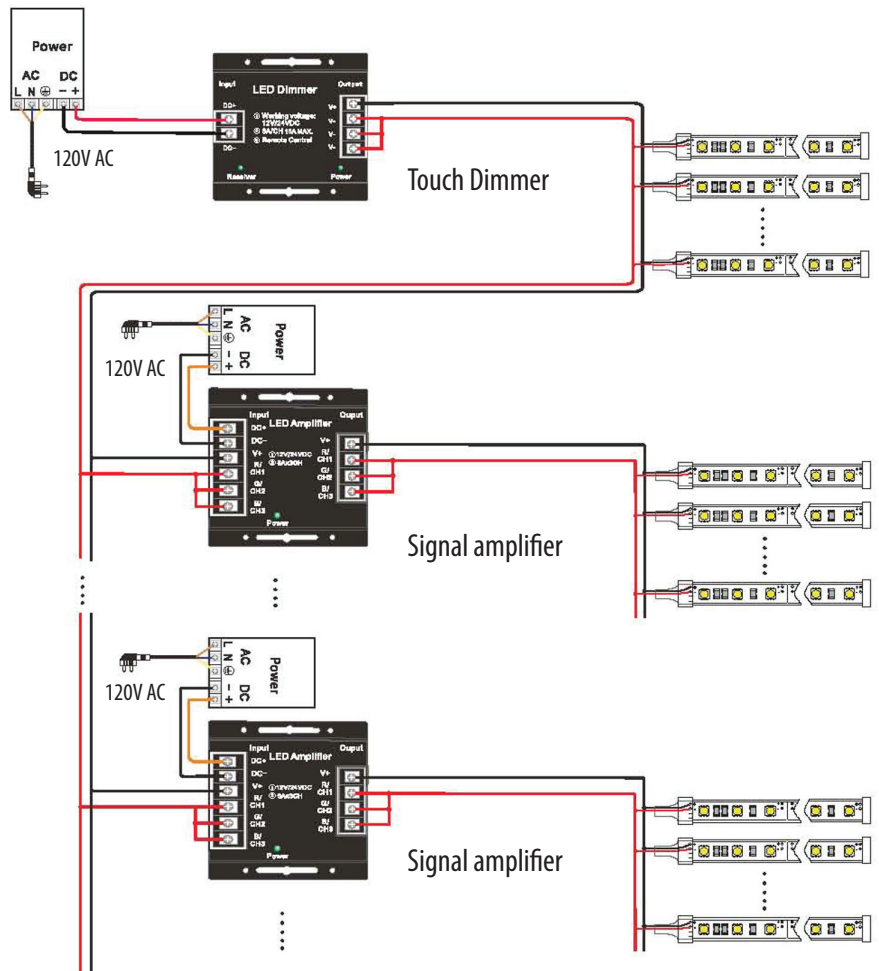

Product dimensions

