

WARNING & CAUTIONS

- Do not operate with the flexible light tightly coiled.
- During installation, make sure flexible light isn't receiving electricity in any manner.
- Make sure the voltage marked on your light strip matches the power supply.
- Do not overlap this product as the overlapping may cause the flexible light to overheat and melt or ignite.
- Do not cover this product as the covering may cause the flexible light to overheat and melt or ignite.
- Do not puncture the flexible lighting.
- Do not route flexible lighting through walls, doors, windows or any like part of the building structure. See wiring diagrams below for remote power source installations.
- Do not use if there is any damage to the light or cord insulation. Inspect periodically.
- Do not submerge flexible light in liquids, or use the product in the vicinity of standing water or other liquids. Keep all parts of LED eStrip installation at least 10 feet from any swimming or decorative pool.
- Secure this flexible light using only the hangers or clips provided. Do not secure this product or its cord with staples, nails, or like means that may damage the insulation.
- Do not subject flexible lighting to continuous flexing.
- Do not exceed the length in feet permitted by the marking.
- Make sure to disconnect the power before adding segments.
- Only use extension segments provided with the entire set of product.
- To preclude the entry of water, make sure that all connections between section segments provided with the entire set of product.
- Do not bend the LED eStrip in the horizontal plane at all. Use "T", "+", "L", or step cords instead. Maintain a minimum 2" radius in the vertical plane.
- Do not subject flexible light to over 35 lbs of tensile force.
- When connecting the flexible light with connectors, step cord, and the power supply (LED driver), make sure the polarity markings are correctly matched.

- When using outdoor use portable lighting products, basic safety precautions should always be followed to reduce the risk of fire, electric shock, and personal injury, including the following:
 - Ground Fault Circuit Interrupter (GFCI) protection should be provided on the circuits or outlet to be used for the outdoor use of flexible lighting product. Receptacles are available having built-in GFCI protection for this measure of safety.
 - Use only listed outdoor extension cord from 120VAC source to LED Driver, such as type SW, SOW, STW, STOW, SJW, SJOW, SJTW, or SJTOW. This designation is marked on the wire of the extension cord.

- Do not mount to any surface that has temperatures exceeding -40F to +104F.

INSTALLATION

DISCONNECT all power before cutting, adding connectors, adding additional LED eStrip, modifying or moving the product in any manner!

CUTTING LED eSTRIP

Cut LED eStrip to desired length (nearest cutting line located every 6") with sharp knife or cable cutters (Figure A). Do not exceed a total of 90 feet of LED eStrip in any single run. Do not exceed total wattage rating of power supply being used.

INSTALLING CONNECTORS

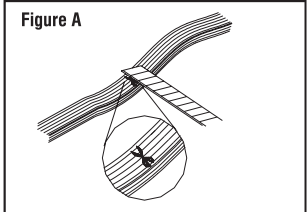
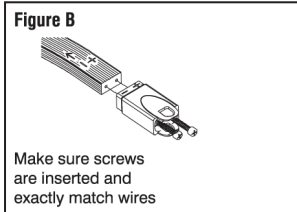
- 

Line up positive and negative polarity markings on male connector with markings on LED eStrip. Place male connector over cut end of LED eStrip and push together firmly (See Figure B).

- Screw threaded contacts of connector into LED eStrip until tight and plastic part of connector is seated firmly against product (Figure B).
- Connect to power supply connector making sure polarity markings are matched (Figure C).

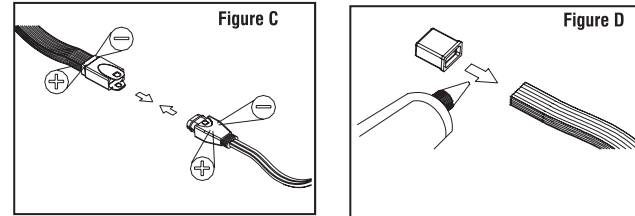

INSTALLING END CAP

Place end cap over dead end of LED eStrip. Secure with a small amount of silicon glue (Figure D).

INSTALLING LOW VOLTAGE POWER CORD

Making sure correct polarity from cord to LED Driver, connect wires from connector to low voltage power supply. Use appropriate strain relief to secure power cord to LED Driver.

ENERGIZING SYSTEM

Connect LED Driver to main power (120 volt). **NOTE** – 120 volt connections to low voltage power supply should be carried out by qualified electrician.

JOINING TWO PIECES OF LED ESTRIP

CAUTION: When joining two pieces of LED eStrip together, **MAKE SURE COMBINED LENGTHS OF TWO PIECES DO NOT EXCEED 90 FEET OF PRODUCT.** Do not exceed rated wattage of power supply.

- Disconnect 120VAC from power supply.
- Remove end cap from LED eStrip, if applicable (Figure E). Clean of glue.

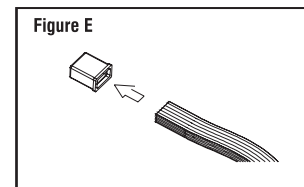

- Line up positive and negative polarity markings on female part of inline connector with markings on LED eStrip. Place connector over cut end of LED eStrip and push together firmly (Figure F).
- Screw threaded contacts of connector into LED eStrip until tight and plastic part of connector is seated firmly against LED eStrip (Figure G).

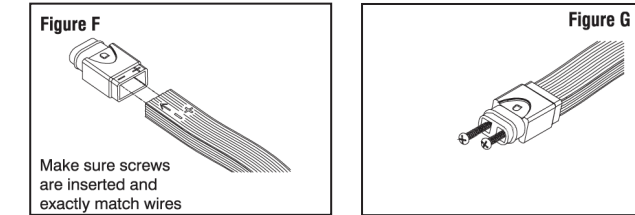

- Repeat steps 3 and 4 for male side of inline connector.
- Line up positive and negative polarity marks on inline connectors and push together until flaps are locked together (Figure H).

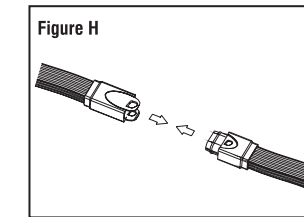

- Note: IMPORTANT SAFETY PRECAUTION! Female side of inline connector should always be attached to the length of LED eStrip that will be attached to power supply.
- Place end cap over dead end of LED eStrip and secure with a small amount of silicon glue.

USING SPECIAL CONNECTORS

When using one of NSL's special connectors (LES-BFXN, LES-BFTR, LES-BFTD or LES-BFLN) please follow steps 1-5 above.

After completing steps 1-5, connect special connector to inline connector by matching appropriate ends and pushing firmly together.

WARNING

To reduce the risk of fire, electrical shock, or injury to persons:

LED DRIVER SELECTION

Low Power	Dimmable Non-Dimming	Min. Feet	Max. Feet
LES-24-65W (Indoor only)	Non-Dimming	1	65
LEDDR-24-120W	Non-Dimming	1	120
TRE24L40DC	Both	18	40
TRE24L96DC	Both	48	90

High Power	Dimmable Non-Dimming	Min. Feet	Max. Feet
LES-24-65W (Indoor only)	Non-Dimming	1	20
LEDDR-24-120W	Non-Dimming	1	42
TRE24L40DC	Both	8	18
TRE24L96DC	Both	22	42

If you do not wish to dim the LED eStrip use any of the LED Drivers listed above and be careful to abide by the minimum and maximum load values listed above.

If you wish to dim the LED eStrip, use only the TRE24L40DC, or TRE24L96DC and a low voltage dimmer listed below. All dimmable LED Drivers have no minimum load when used with an appropriate dimmer, however, all dimmable LED Drivers are more efficient if specified as per the minimum and maximum load values listed above.

- Our dimmable power supplies are dimmable with any standard MLV/Incandescent TRIAC (Leading edge) dimmer switches. Dimmer switches are to be installed on the input (120VAC) of the driver.
- Carefully following the dimmer instructions, dimmable LED power supply instructions, and the NEC, wire dimmer between 120VAC power input and 24 Volt Direct Current dimmable LED power supply.

WIRING INSTRUCTIONS

Assure power is disconnected from LED eStrip.

- Use only 18AWG wire of the following specifications:
 - For all interior applications use only our molded cords with "CL2" wire NSL model number LES-001-6CL, LES-001-12CL, LES-STP-2CL, LES-STP-12CL.
 - For all outdoor applications, use only our molded cords with "Direct Burial" wire, NSL Model numbers LES-001-6BR, LES-001-12BR, LES-STP-2BR, LES-STP-12BR.
- First, make sure LED Driver is not receiving power in any way. Wire LED eStrip per these instructions, assure proper connection and polarity on all fittings and strain reliefs, and then apply 120VAC power to LED Driver.
- Low voltage Power Cord can be shortened or lengthened by cutting to desired dimension and placing cut end/splice in power supply box or LMSII-001 junction box(es). Low voltage male/male extension cord can be shortened or lengthened by cutting to desired dimension and placing splice(s) in LMSII-001 junction box(es). **CAUTION:** All splices and connections are only allowed exterior to all walls or structural members.
- Never exceed a total of 100 feet of power cords or step cords per single run of LED eStrip.
- Do not try to adjust, fix, rewire, LED eStrip. In the unlikely event LED eStrip does not illuminate, check connections and wiring polarity first. If this does not work, send LED eStrip back for warranty replacement, if applicable.

NOTE: These products may represent a possible shock or fire hazard if improperly installed or attached in any way. Products should be installed in accordance with the owner's manual, current local codes, and/or the current National Electrical Code (NEC).

LED eSTRIP CABINET WIRING

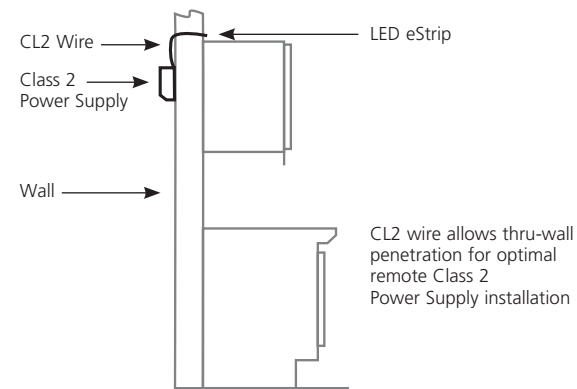

LED eSTRIP BURIAL WIRING

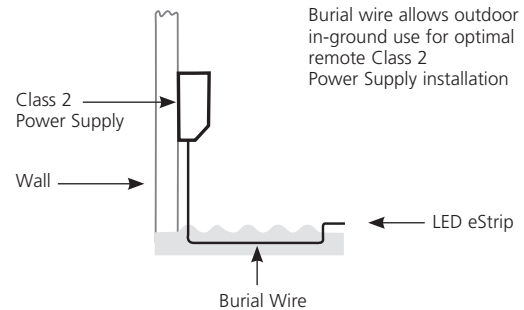

DIMMING REMOTE POWER SUPPLY INSTALLATION FLOW CHART

Low Voltage CL2 Wire Interior to Walls or Structural Members

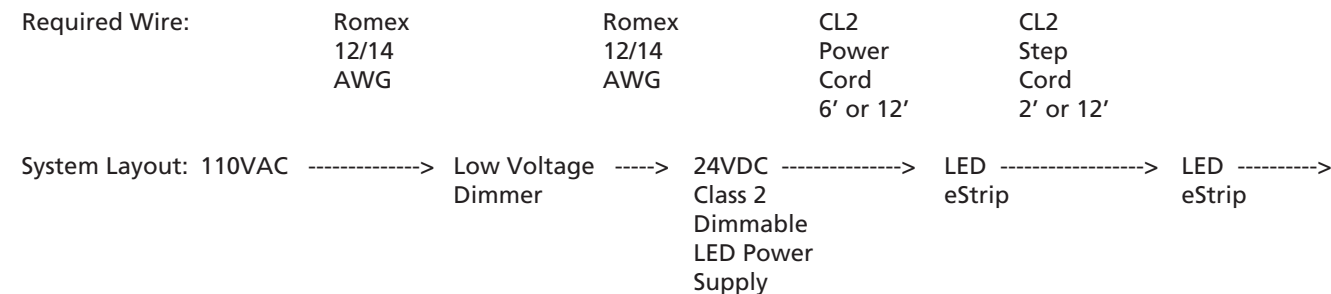

NOTE: If you Do Not want LED eStrip to dim, the above charts are modified to remove "Low Voltage Dimmer", the power supply becomes "Non-Dimmable" LEDDR-24-120W. As always, check the current NEC and local building codes for acceptance of your application design.

Fixture stranded lead wire should never penetrate any wall. Fixture stranded lead wire may penetrate through cabinets with access doors to all interior spaces. Only the UL listed CL2 lead wire may penetrate walls allowing the power supply to be mounted in an adjacent room to the fixture application.

After assuring wiring is correctly installed as per all diagrams, +/- polarity is maintained throughout, and all terminal block screws are tightened, cover all terminal block connections with junction box covers and included screws. Mount junction box to surface using included double-sided tape and/or wood screws. Lead wires should be neatly affixed to mounting surface with WSC-004 wire screw clips.

ACCESSORIES

LES-010
Channel track

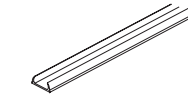

LES-005
Wood nail clip

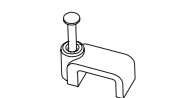

LES-008
Saddle mounts with tie wrap

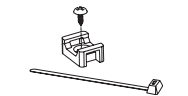

LES-002
Male and female in-line connector set

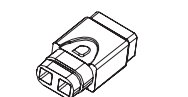
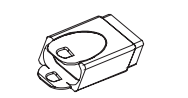

LES-003-2
Push-On Female End Cap

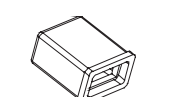

LES-003-03
Molded Female End Cap



LES-001-XXX
Power cord
CL2 or Burial
6 ft or 12 ft



LES-STEP-XXX
Step cord
CL2 or Burial
2 ft or 12 ft



LES-BFLN
"L" Type Connector

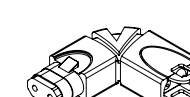

LES-BFTD
"T" Type Connector
connector in bottom



LES-BFTR
"T" Type Connector
connector in right or left

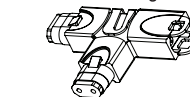

LES-BFXN
"X" Type Connector



INSTALLATION INSTRUCTIONS

LED eSTRIP

THE FIELD CUTTABLE FLEXIBLE SOLUTION FOR LOW ENERGY USAGE LINEAR LIGHTING

CAUTION:
READ AND FOLLOW ALL SAFETY INSTRUCTIONS

Cove Lighting

Eave Lighting

Deck Lighting

Stairs

Under/Over Cabinet Lighting

Visual Merchandising

Exhibit Projects

Theatrical Projects

SPECIFICATIONS

Electrical Rating	0.96 watts/ft, 40mA, 24VDC 2.2 watts/ft High Power model
Max. Single Run	90 Feet, 40' High Power model
Cutability	Every 6" at scissor mark
Average LED Life	35,000 hours at 70% illumination
Mounting Surface Temperature Limits	-40F to +104F
PVC Color	Clear
LED Colors	Warm White, Cool White, Amber, Red, Blue, Green

NATIONAL SPECIALTY LIGHTING
ARCHITECTURAL AND DECORATIVE LIGHTING
2299 Kenmore Ave, Tonawanda, NY 14207
www.nslusa.com

© 2016 National Specialty Lighting

1/16

NSL
NATIONAL SPECIALTY LIGHTING
YOUR TRUSTED LIGHTING PARTNER

ETL
Intertek
Wet Locations