

## A FIELD CUTTING eSTRIP SERIES

Please follow the recommended scissors mark to cut the LED eStrip and comply with the instruction of maximum single run.

**NOTE:** Misapplication will cause the product to malfunction.

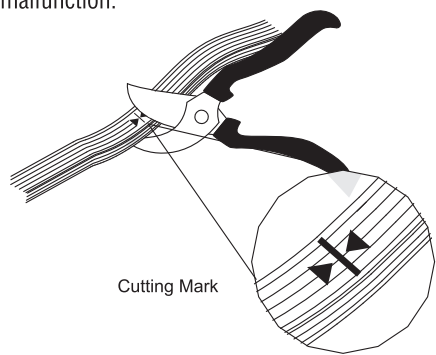

Cutting Mark

Insert the LED eStrip into the male connector and firmly connect LED eStrip with the connector.

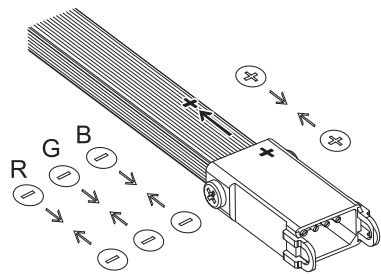

**POLARITY CAUTION!** When connecting male connector to LED eStrip, make sure + sign on connector is lined up with + sign on LED eStrip with arrow on LED eStrip pointing AWAY FROM POWER SUPPLY.

## B MALE CONNECTOR FABRICATION

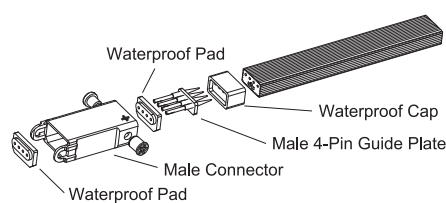

1. Insert the waterproof cap into the LED eStrip, ensuring the stopper's cavities are lined up with the bare copper wire of the LED eStrip.

2. Use a small hammer and lightly hit the fixture to push the male 4-pin guide plate into the LED eStrip. Make sure the male 4-pin guide plate remains flat at all times while connected onto the LED eStrip.

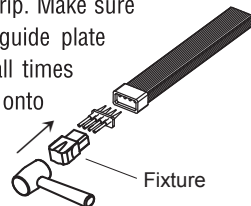

3. Push one of the waterproof pads onto the male 4-pin guide plate, and then connect the male connector with the LED eStrip, making sure the connector completely covers the male 4-pin guide plate (ensure the waterproof pad is secured inside the male connector).

4. Secure the male connector to the LED eStrip with Allen wrench or suitable screwdriver.

5. Male connector fabrication is complete.

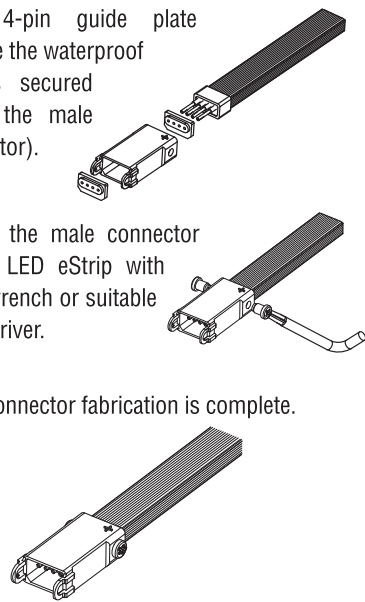

## FEMALE CONNECTOR FABRICATION

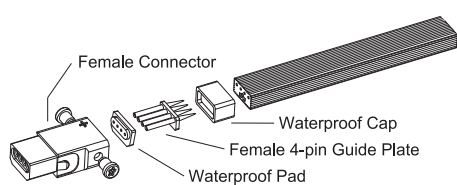

1. Insert the waterproof cap into the light strip, ensuring the stopper's cavities are lined up with the bare copper wire of the eSTRIP.

2. Use a small hammer and lightly hit the fixture to push the female 4-pin guide plate into the eSTRIP. Make sure the female 4-pin guide plate remains flat at all times while connected onto the eSTRIP.

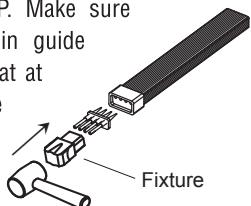

3. Push the waterproof pad onto the female 4-pin guide plate, and then connect the female connector with the eSTRIP, making sure the connector completely covers the female 4-pin guide plate (ensure the waterproof pad is secured inside the female connector).

4. Secure the female connector to the eSTRIP with Allen wrench or suitable screwdriver.

5. Female connector fabrication is complete.

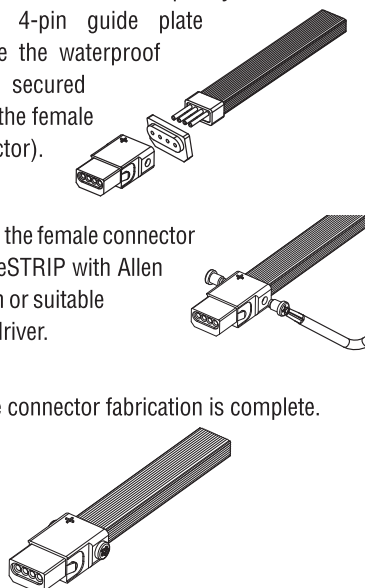

## C INSTALL END CAP OR CONNECT TO ANOTHER LED eSTRIP

To extend LED eStrip, attach a male connector to one section of the LED eStrip and a female connector to the other section of the LED eStrip and then connect them together firmly.

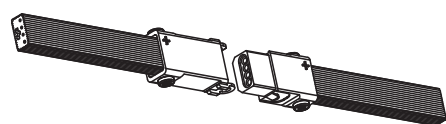

**POLARITY CAUTION:** Arrow on LED eStrip should be pointing AWAY FROM MALE CONNECTOR and TOWARDS FEMALE CONNECTOR. When connecting male connector to LED eStrip, make sure + sign on connector is lined up with + sign on LED eStrip with arrow on LED eStrip pointing AWAY FROM POWER SUPPLY.

When no extension is required, please disconnect the LED eStrip from the power first. Attach an end cap to the end of the LED eStrip and secure

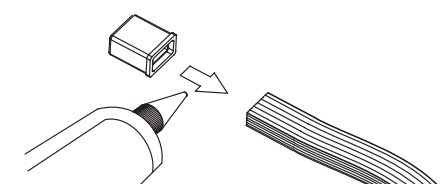

it on the LED eStrip with glue or silicone to reach the best waterproof protection. (This installation should be operated in dry location.)

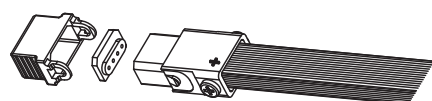

To enhance the waterproof level, you can attach a female connector to the end of the LED eStrip and make connection with a female end cap (please make sure the waterproof pad is secured inside the female end cap).

## D CONNECT TO POWER

Connect the light strip with the power supply.

**POLARITY CAUTION!** When connecting male connector to LED eStrip, make sure + sign on connector is lined up with + sign on LED eStrip with arrow on LED eStrip pointing AWAY FROM POWER SUPPLY.

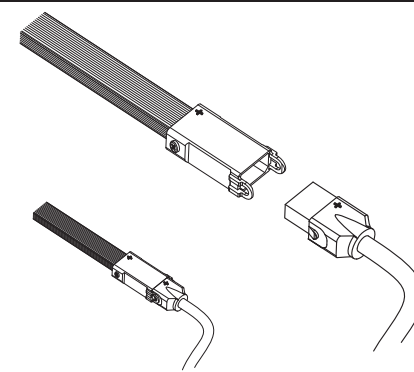

## E INSTALLATION PROCEDURES

### The Extension Procedure

Please follow the steps to extend the light strip.



### The Termination Procedure

Please follow the steps to end the last section of the light strip.



## CONTROL OF RGB eSTRIP SERIES

**NOTE:** As LED eStrip Series is powered by class 2, 24V power supplies, you will need one power supply and one controller for the first 40' run of LED eStrip Series. A signal amplifier and additional class 2 power supply will be required for each additional 40' (or part thereof) of LED eStrip.

In outdoor situations, Power supplies, controllers and repeaters must be placed in weather proof enclosures or be outdoor rated.

1. Connect color coded wires from female end of power feed connector to output side on Controller. The output side of the controller is marked +, R, G, B to match wire colors from power feed. The black wire on the power feed goes to the + terminal on the controller.

2. Connect this female end to male end attached to RGB outdoor LED eStrip (see connector fabrication details in these instructions) making sure connection is secured tightly to keep water out.



3. Connect input side of controller to appropriate size of 24V power supply from list of approved power supplies.

**NOTE:** Use only LEDDR-24-120W power supplies when controlling LED eStrip. Do not use Dimmable power supplies for color change applications.

4. Connect line voltage side of power supply to line voltage.

**NOTE:** Line voltage connections should be carried out by a qualified electrician.

For Installations with multiple lengths of LED eStrip, you will need a signal amplifier for each additional run as follows:

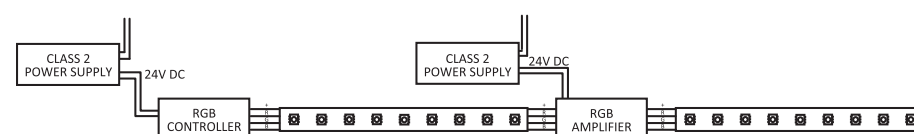

1. Using part #LES-BTMC-G4-SI connector, connect bitter end of existing eStrip to signal input side of outdoor signal amplifier. (See Male Connector Fabrication).

2. Connect next length of LED eStrip to Signal Output of amplifier using part #LES-BTMC-G4-SO. (see Male Connector Fabrication)

**NOTE:** Be sure to use LES-BTMC-G4-SO only on output side of amplifier and LES-BTMC-G4-SI only on input side of amplifier to assure polarity of product is maintained. Arrow on LED eStrip always points away from power supply.

3. Connect 24V power from output of new 24V Class 2 Power supply to Voltage Input of amplifier using part # LV-CN-G2.

4. Connect primary side of power supply to mains voltage.

**Summary:** The RGB amplifier receives Pulse Width modulation (PWM) signal from the controller allowing you to do multiple runs from a single controller. They are powered individually by a class 2 power supply. The power supply should match the wattage of the length of LED eStrip series you are controlling.



## WARNING AND CAUTIONS

- Do not operate with the flexible light tightly coiled.
- During installation, make sure flexible light isn't receiving electricity in any manner.
- Make sure the voltage marked on your light strip matches the power supply.
- Do not overlap this product as the overlapping may cause the flexible light to overheat and melt or ignite.
- Do not puncture, cut, shorten, or splice the flexible lighting.
- Do not route flexible lighting through walls, doors, windows or any like part of the building structure. See wiring diagrams for remote power source installations.
- Do not use if there is any damage to the light or cord insulation. Inspect periodically.
- Do not submerge flexible light in liquids, or use the product in the vicinity of standing water or other liquids. Keep all parts of LED eStrip installation at least 10 feet (305cm) from any swimming or decorative pool.
- Secure this flexible light using only the hangers or clips provided. Do not secure this product or its cord with staples, nails, or like means that may damage the insulation.
- Do not subject flexible lighting to continuous flexing.
- Do not exceed the length in feet permitted by the marking.
- Make sure to disconnect the power before adding segments.
- Only use extension segments provided with the entire set of product.
- To preclude the entry of water, make sure that all connections between section segments are secure.
- Do not bend the LED eStrip in the horizontal plane at all. Use "T", "+", "L", or step cords instead. Maintain a minimum 2" (5.1cm) radius in the vertical plane.
- Do not subject flexible light to over 15 lbs. of tensile force.
- When connecting the flexible light with connectors, step cord, and the power supply (LED driver), make sure the polarity markings are correctly matched.
- When using outdoor use portable lighting products, basic safety precautions should always be followed to reduce the risk of fire, electric shock, and personal injury, including the following:
  - Ground Fault Circuit Interrupter (GFCI) protection should be provided on the circuits or outlet to be used for the outdoor use of flexible lighting product. Receptacles are available having built-in GFCI protection for this measure of safety.
  - Use only listed outdoor extension cord from 110VAC source to LED Driver, such as type SW, SOW, STW, STOW, SJW, SJOW, SJTW, or SJTOW. This designation is marked on the wire of the extension cord.

## ACCESSORIES

### CONNECTOR & MOLDED CONNECTOR

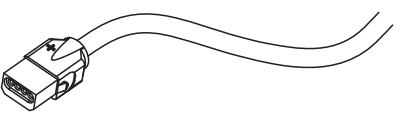

CODE	DESCRIPTION	LENGTH OF WIRE
LES-BTMCJ-1.5	4C power connector	1.5' (.46m)
LES-BTMCJ-6	4C power connector	6' (1.83m)
TCJ-E06	4C Extension Cord	6' (1.83m)
TCJ-E30	4C Extension Cord	30' (9.14m)

### CONTROLLERS & AMPLIFIERS



CODE	DESCRIPTION
LT-09S-RF	Key RGB "Touch" Controller 12/24V DC
LT-031-RF	6 Key CCT Adjustable "Touch" Controller 12/24V DC
LT-032-RF	6 Key Dimming "Touch" Controller 12/24V DC
LV-ZJFFS-3CH-6INW	Signal Amplifier for RGB 12/24V DC, 3 Channel, Outdoor
LV-RF103	Wireless RF Mini RGB Controller 24V, 96W
LN-CON-WiFi-3CH-XV	WiFi controller for RGB, CCT, and Dimming, c/w RF remote 12/24VDC

### MALE & FEMALE CONNECTOR

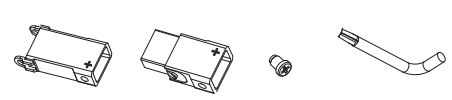

CODE	DESCRIPTION
LES-BTFN	Female Connector
LES-BTMN	Male Connector
LES-BTSN	In-Line Connector Set (Male & Female)
LES-MX-1	Allen Wrench (for connector installation)
LES-BTMC-G4-SI	Signal In Connector for connection to Signal Amplifier
LES-BTMC-G4-SO	Signal Out Connector for connection to Signal

## MOUNTING ACCESSORIES

### END CAP



CODE	DESCRIPTION
LES-STCN	Cutting End Cap
LES-STFN	Female End Cap

### TIE STRIP



CODE	DESCRIPTION
LES-C-6	Tie Strip

### WOOD NAIL CLIP



CODE	DESCRIPTION
LES-SNPT	Wood Nail Clip

### U-CHANNEL

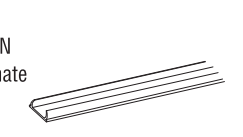

CODE	DESCRIPTION
LES-STPV-T	Poly Carbonate U-Channel 39.4" (1m)

## SPECIFICATIONS

### RGB eStrip Dimensions = 15mm x 7.6mm (± 0.5mm)

LED Color / Type	RGB SMD
LED Spacing	33mm (1.3")
Voltage	DC 24V
LEDs per Section	6 pieces
Cutting Length	20cm (7.9")
Max. Single Run	12m (40')
Power Consumption	7.2W/m (2.2W/ft)

### RGB Amplifier Technical Parameters

Working temperature	-20C – +60C
Supply voltage	Class 2, 24V
Output	3 channels
External dimensions	L 140mm x W 70mm x H 50mm
Static power consumption	< 1W
Efficacy	< 4A each channel
Maximum length of LED eStrip per amplifier	12.8m (42')

### Non Dimmable Drivers

#### LEDDR-24-120W

Outdoor driver  
120W hardwire  
Max 42' (12.8m) per single tap  
Max 54' (16.4m) combined 2 secondary taps  
Input: 100 - 240V AC  
Output: 24V DC  
10" x 3 3/8" x 3 3/16"  
(254 x 85.7 x 80.9mm)

## INSTALLATION AND SAFETY INSTRUCTIONS

# LED eStrip, RGB

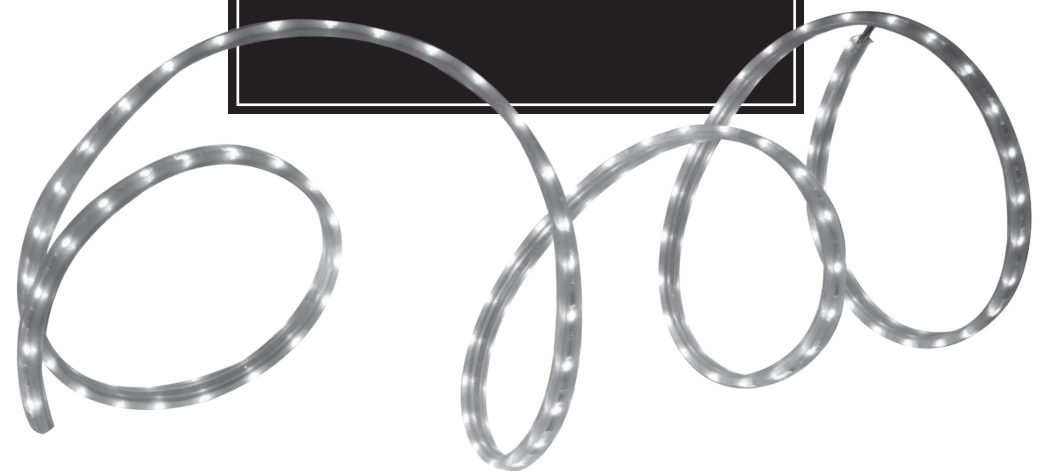

### Applications

- Aisle and stairway lighting
- Cabinet and Cove lighting
- Deck and patio lighting
- Pathway lighting
- Building facades and outlines
- Back lighting
- Showcase lighting
- Linear decorative lighting